

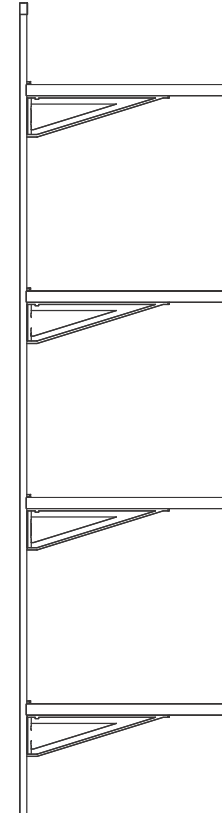

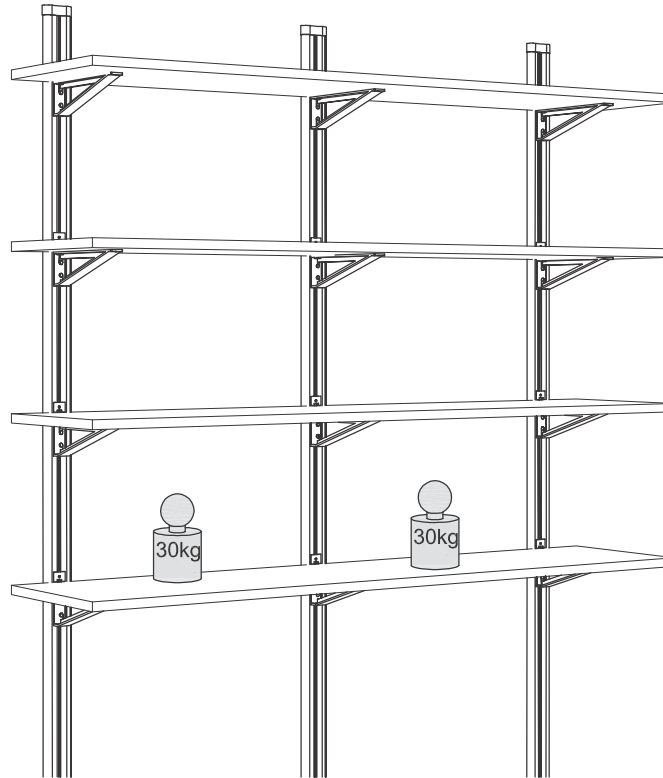

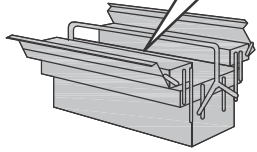

# Montageanleitung Halbprofil mit Regalträger

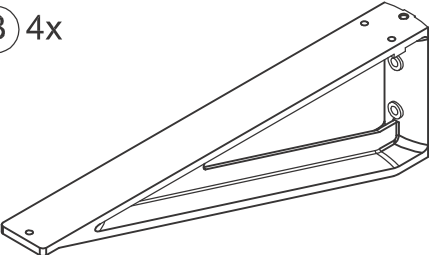
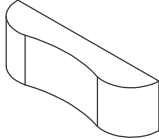

<p><b>A</b> 4x</p> 	<p><b>B</b> 4x</p> 	<p><b>C</b> 1x</p> 	<p><b>D</b> 4x</p>  <p>10,1x1,8</p>	<p><b>E</b> 4x</p>  <p>3x13</p>	<p><b>F</b> 3x</p>  <p>5x60</p>	<p><b>G</b> 3x</p>  <p>8x51</p>	<p><b>H</b> 3x</p>  <p>5x40</p>	<p><b>J</b> 3x</p>  <p>8x40</p>	
---	--	--	--	--	--	--	--	--	--

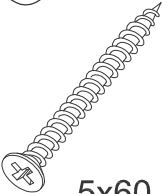
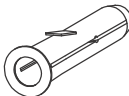
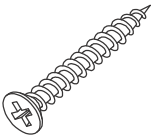
1

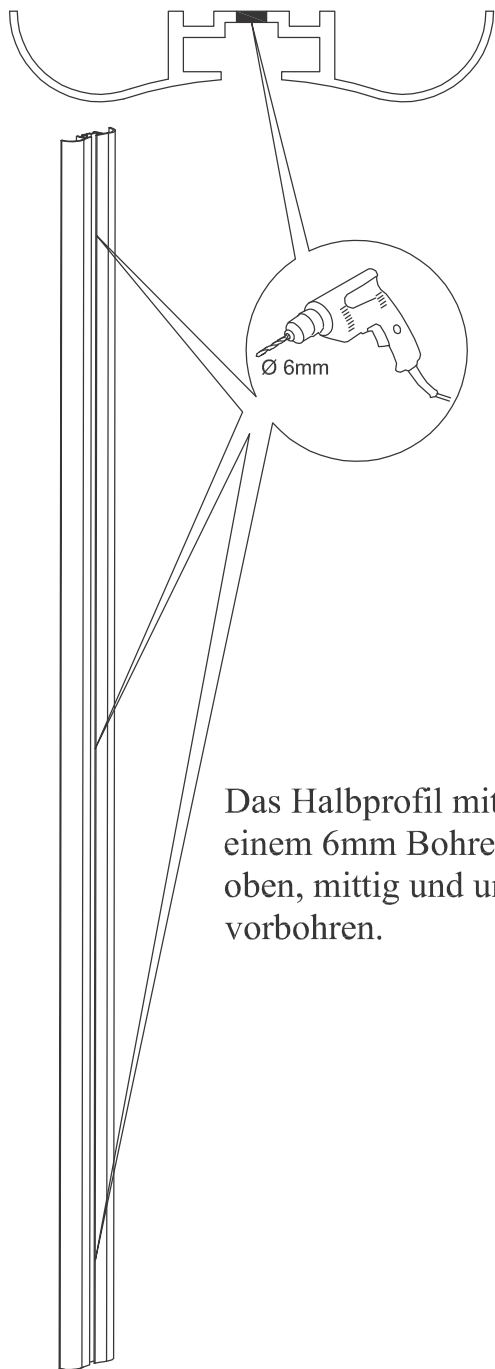

Das Halbprofil mit einem 6mm Bohrer oben, mittig und unten vorbohren.

2



Das Halbprofil an die gewünschte Stelle der Wand halten und durch die vorgebohrten Löcher hindurch markieren.

3

**F** PREMIUM

Strich

Strich

Strich

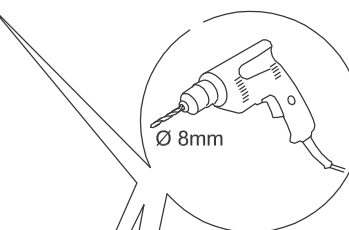

An den markierten Stellen mit einem 8mm Bohrer einsetzen und der Dübellänge entsprechend bohren. Anschließend die Dübel einsetzen. Bei einigen Wandtypen kann ein Spezialdübel erforderlich sein!

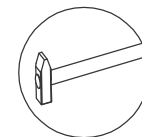
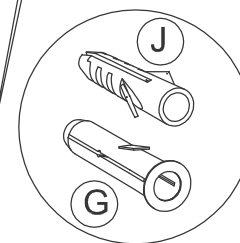

4

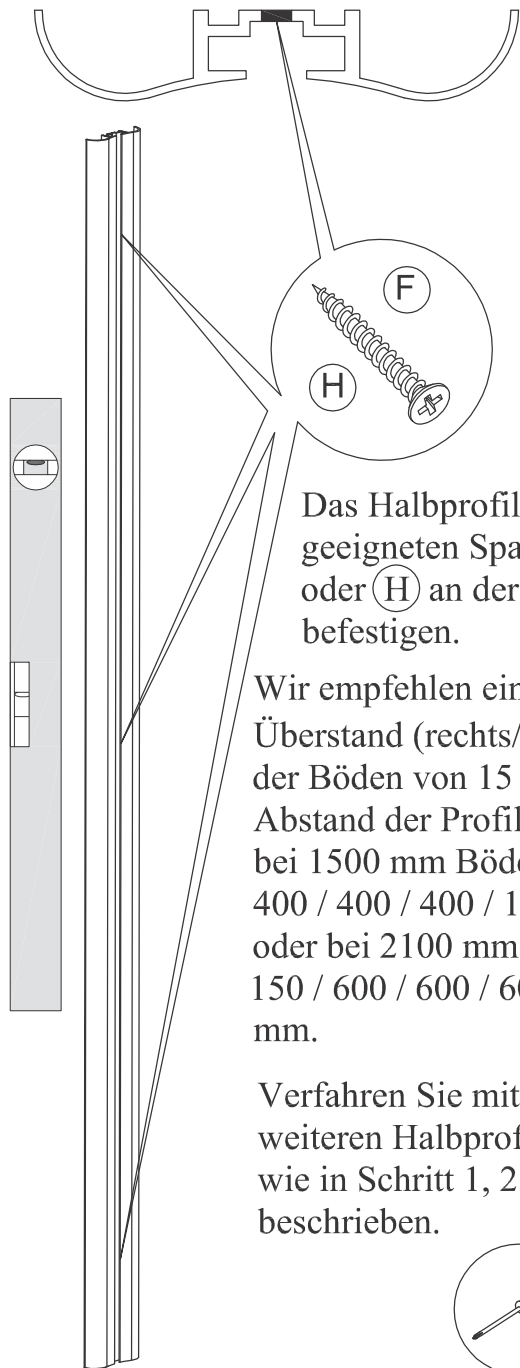

Das Halbprofil mit der geeigneten Spax (F) oder (H) an der Wand befestigen.

Wir empfehlen einen Überstand (rechts/links) der Böden von 15 cm. Abstand der Profile z. B. bei 1500 mm Böden: 150 / 400 / 400 / 400 / 150 mm oder bei 2100 mm Böden 150 / 600 / 600 / 600 / 150 mm.

Verfahren Sie mit allen weiteren Halbprofilen wie in Schritt 1, 2, und 3 beschrieben.

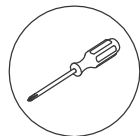

5

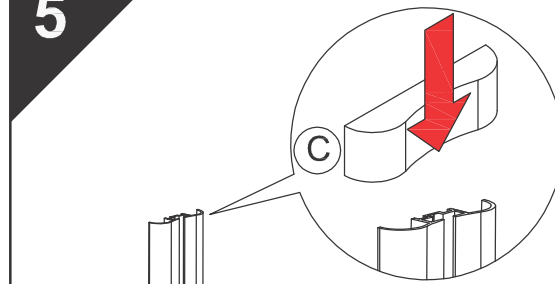

Abdeckkappe oben aufstecken.

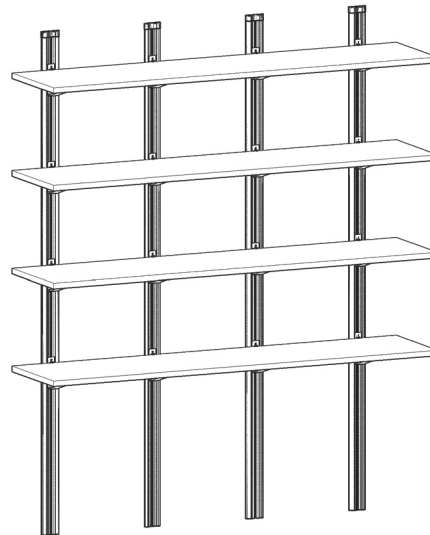

6

**F** PREMIUM

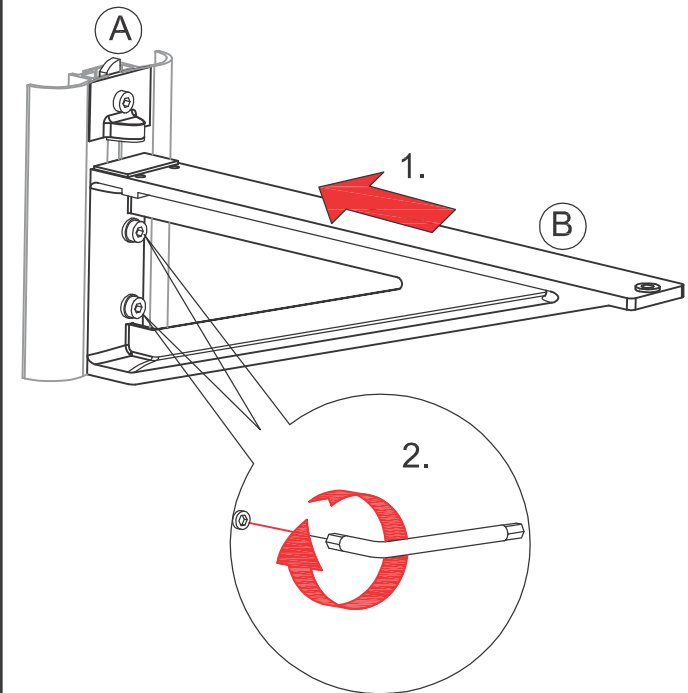

Regalträger (B) mit dem Klemmblech am Profil anbringen.

7

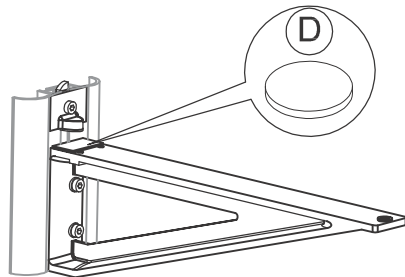
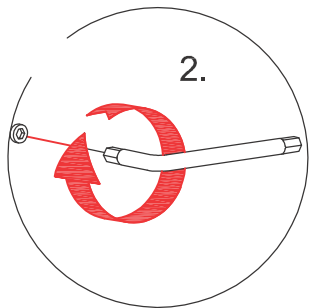
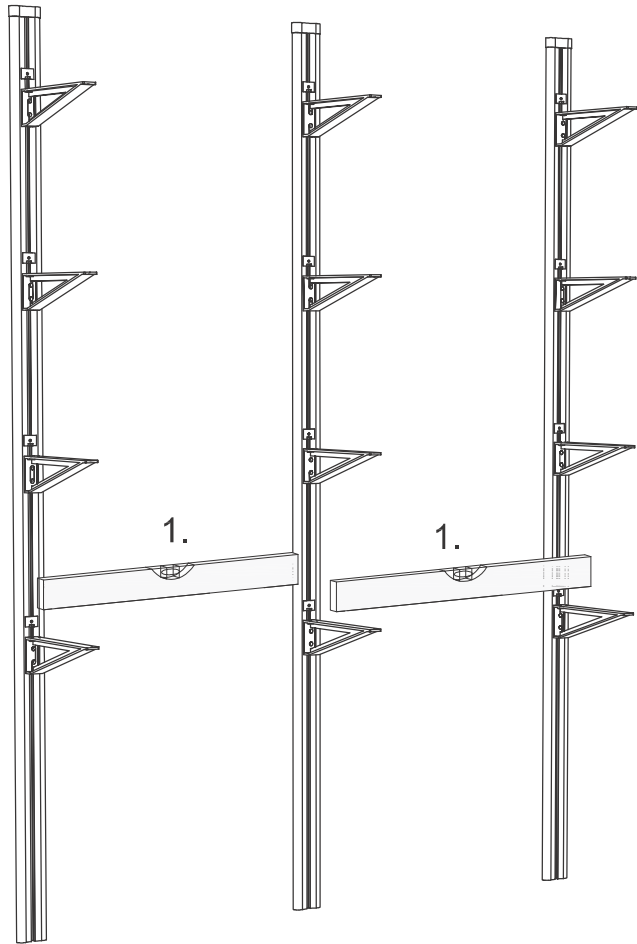
**PREMIUM**

8

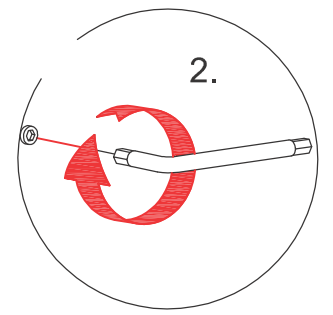
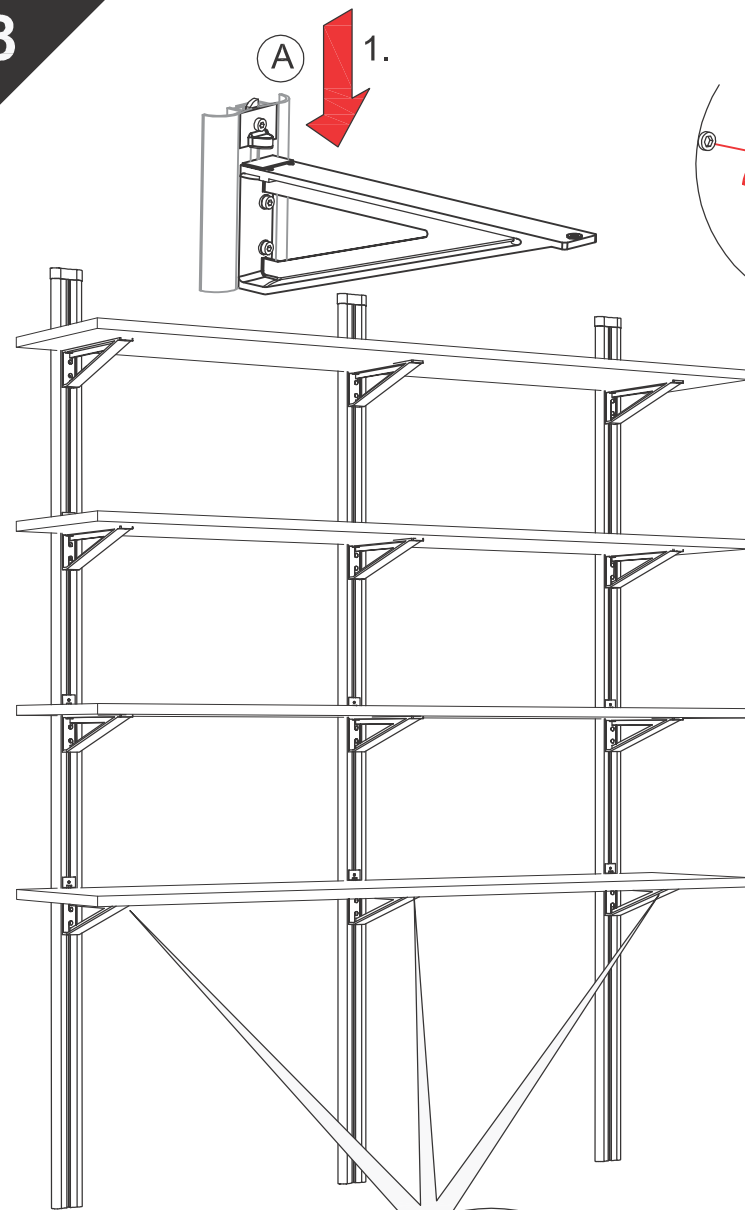

Die Böden  
auflegen und  
den Gegenhalter  
A mit dem  
Klemmblech am  
Profil fixieren.

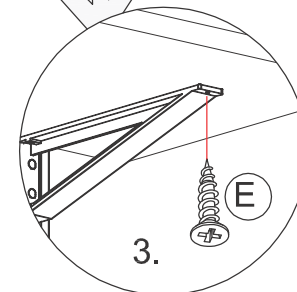
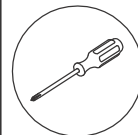

Anschließend die  
Böden vorne mit  
Spaxschraube E  
fixieren.